



PRECISE ELECTRIC MFG. CO., LTD.

Surge Arresters Type LAS-002

Performance Characteristics of Surge Arresters type LAS-002

Applied standard	IEC 61643-1	
Type of arresters	ZnO Gapless	
Rated voltage of arresters (U_r)	V, rms	480
Maximum Continuous operating voltage (U_c)	V, rms	480
Rated frequency	Hz	50
Nominal discharge current (I_n), 8/20 us waveshape	kA, peak	5
Maximum discharge current (I_m), 8/20 us waveshape	kA, peak	10
Test classification	-	II
Measured limiting voltage	kV, peak	2
Short Current withstand capability test (I_p)	kA, r.m.s	10
Dielectric withstand test, 1 min	V, rms	3.3
Housing material of arresters	-	ABS
Weight of one surge arrester including accessories	kg.	0.22

Line Lead Clamp suitable for aluminum
Conductor size 25 mm² to 120 mm²

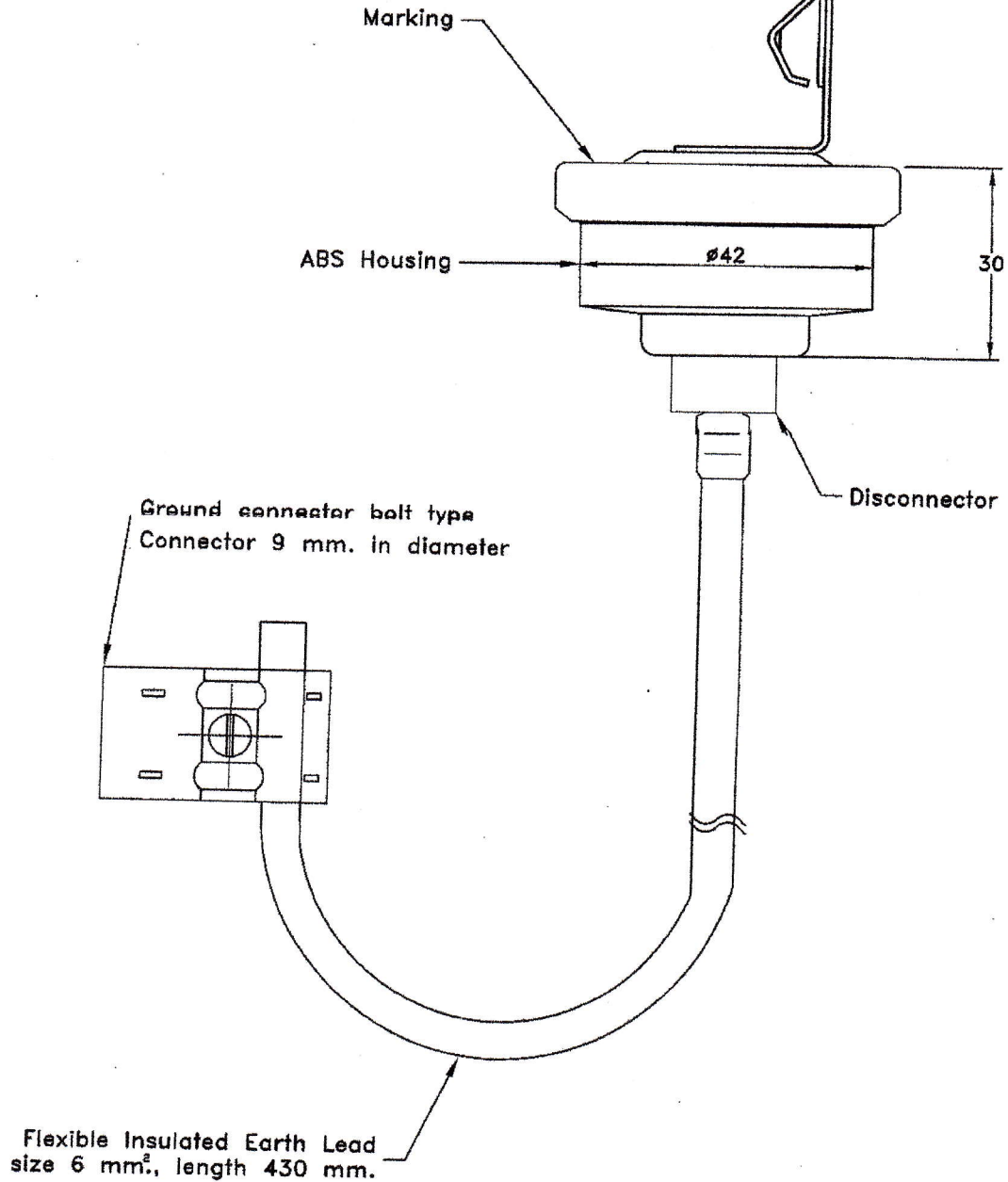

±10% TOLERANCE FOR FREE DIM.		— SURFACE KLASIF. OF QUA.		SURGE ARRESTERS & POLYMER PRODUCTS DIVISION			SCALE —	UNIT : M.M.	MASS KGS./PIECE
QUALITY ASSURANCE				DESIGN	NAME	Authorize	DATE	NO. [] [] [] [] [] [] [] [] [] []	
CHECK	NAME	DATE	CHECK	PTC	<i>[Signature]</i>	<i>[Signature]</i>	LOW VOLTAGE SURGE ARRESTERS TYPE LAS-002 480 V 5 KA		
ISSUE	CHANGE NO.	DATE	APPROVED	NPP	<i>[Signature]</i>	<i>[Signature]</i>	LS-F-99-2001		PAGE 1
									NO. PAGES 1

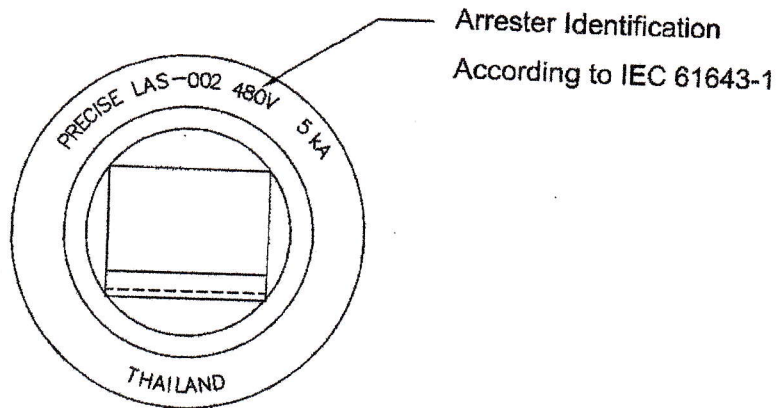
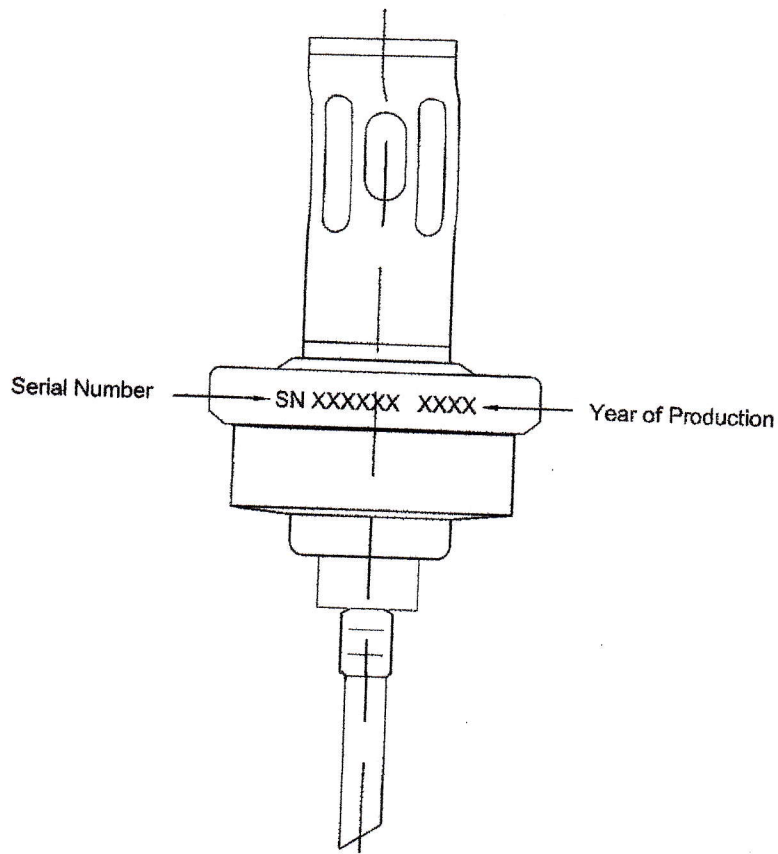

±0.5 TOLERANCE FOR FREE DIM.		- SURFACE KLASIF. OF QUA.		SURGE ARRESTERS & POLYMER PRODUCTS DIVISION			SCALE	-	UNIT : M.M.	MASS KGS./PIECE
QUALITY ASSURANCE				NAME	Authorize	DATE	MATERIAL			
CHECK		NAME	DATE	DESIGN	PTC	17/10/10	STAINLESS STEEL 304			
ISSUE	CHANGE NO.	DATE	NAME	CHECK	PTC	19/10/10	TOP END CAP NO REMARK PEA (LAS-002)			
				APPROVED	NPP	19/10/10	NO. <input type="text"/>			
							PAGE 1			
							NO. PAGES 1			

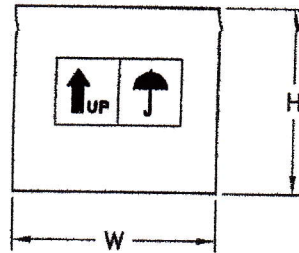
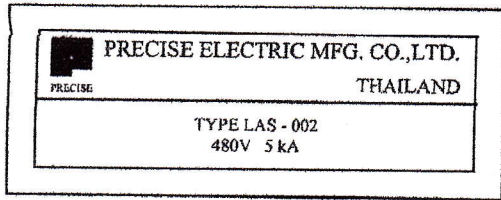

SMALL BOX

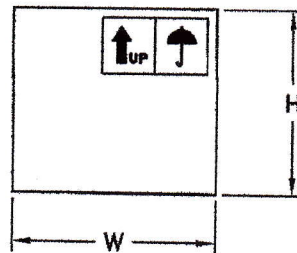
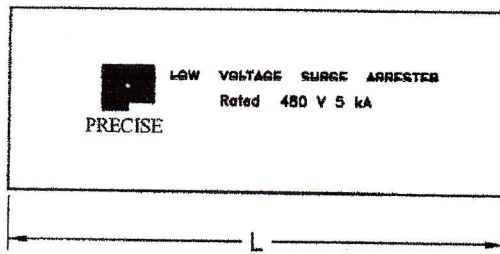

FRONT VIEW

SIDE VIEW

CARTON BOX

PACKING	SET(S)	DIMENSION MM. (APPROX.)			WEIGHT.KG. (APPROX.)
		H	W	L	
SMALL BOX	1	50	145	50	0.16
CARTON BOX	100	280	280	610	16

±0.5 TOLERANCE FOR FREE DIM.		- SURFACE KLASIF. OF QUA.		SURGE ARRESTERS & POLYMER PRODUCTS DIVISION			SCALE -	UNIT : M.M.	MASS KGS./PIECE
QUALITY ASSURANCE				MATERIAL -			NO. [] [] [] [] [] [] [] [] [] []		
NAME		DATE		DESIGN	PTC	Authorize	LAS-002 480 V, 5 kA FOR SMALLBOX AND CARTON BOX		
CHECK		CHECK		CHECK	PTC				
ISSUE	CHANGE NO.	DATE	NAME	APPROVED	NPP				
							PRECISE		
								PAGE 1	
								NO. PAGES 1	